

© 2008 Alan Sinclair Wizardofflight@Comcast.net

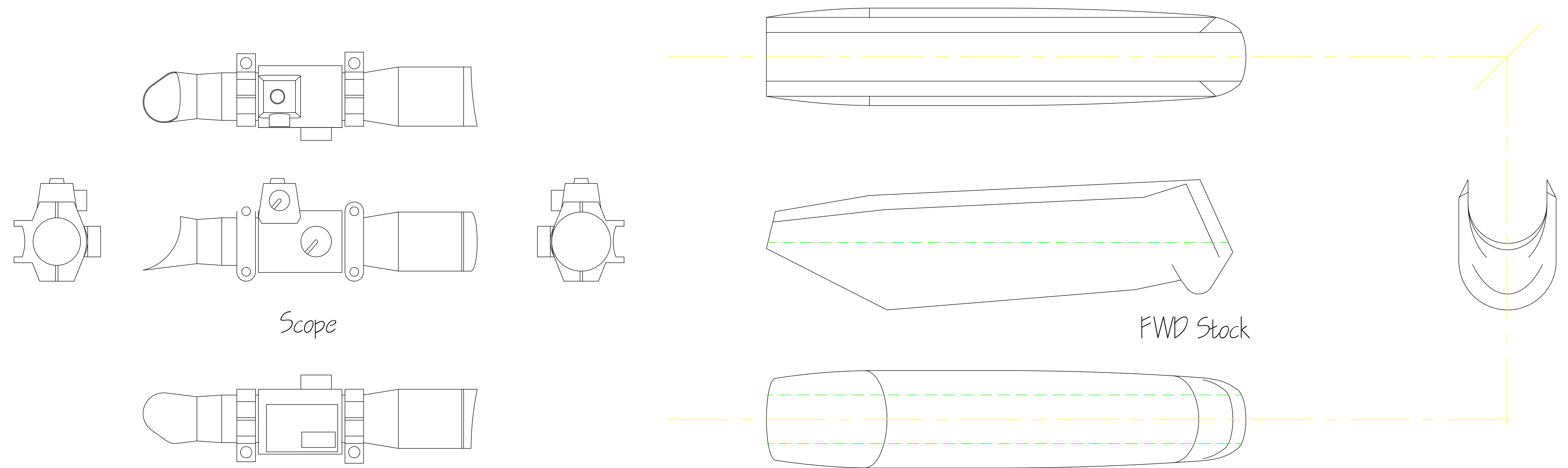

25.43

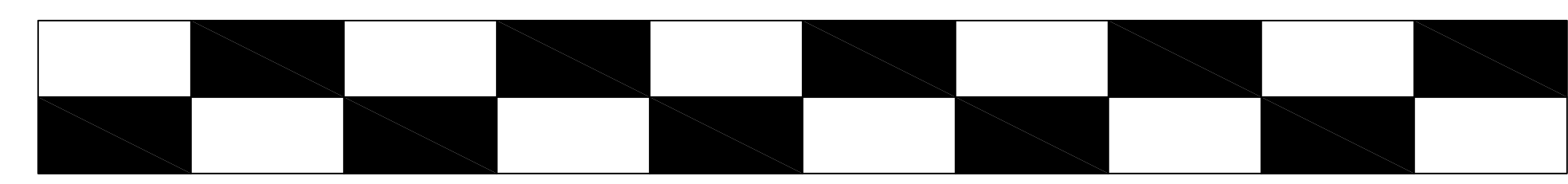
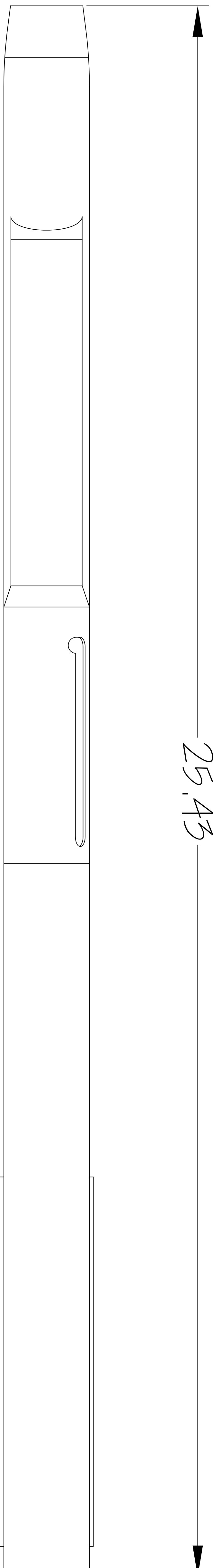

Upper Receiver

11.55

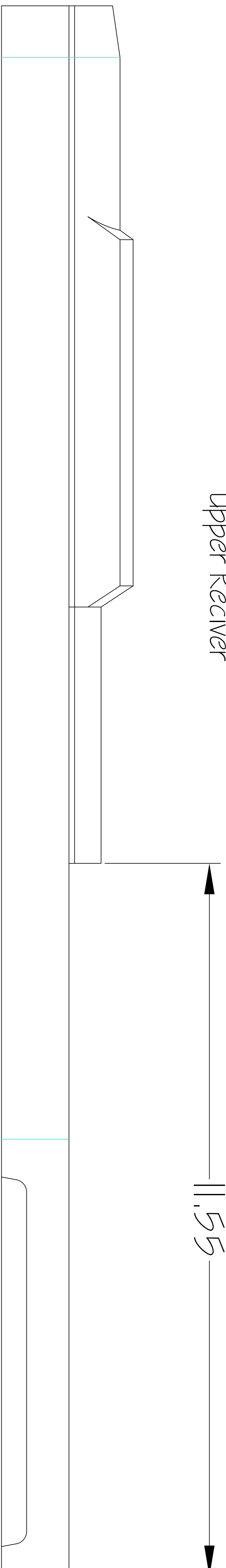

4.43

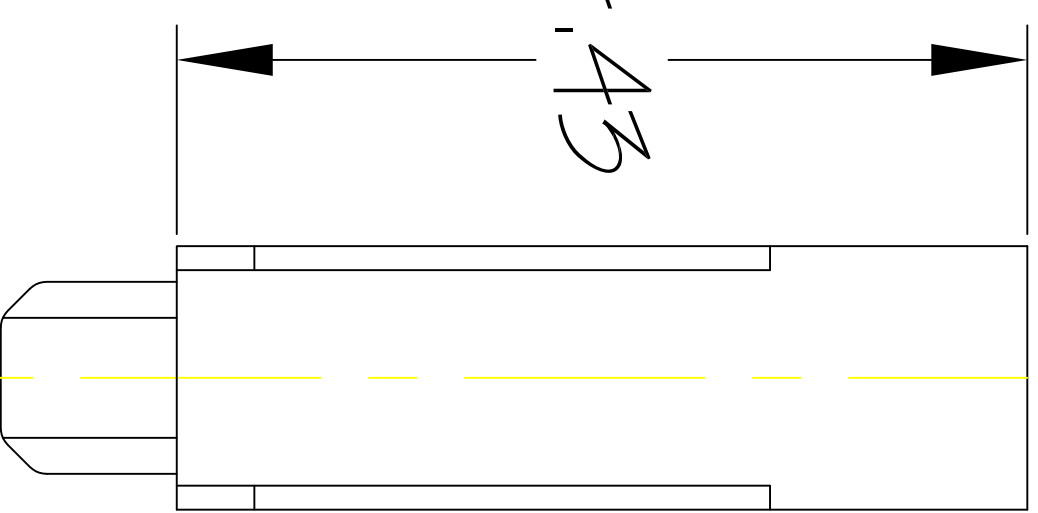

Chamfer Lower Exposed edge

© 2008 Alan Sindair Wizardofflight@Comcast.net

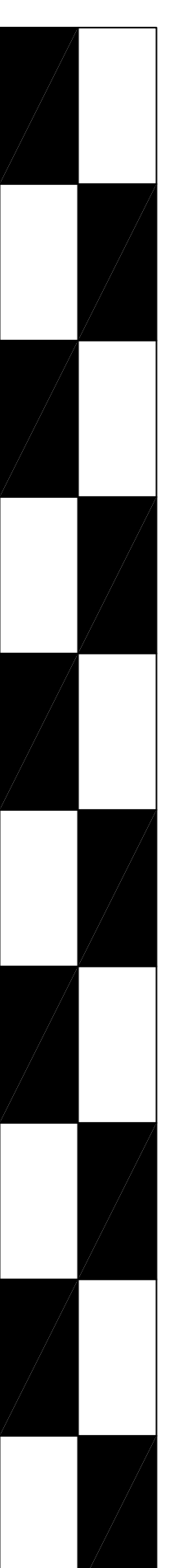

5.35

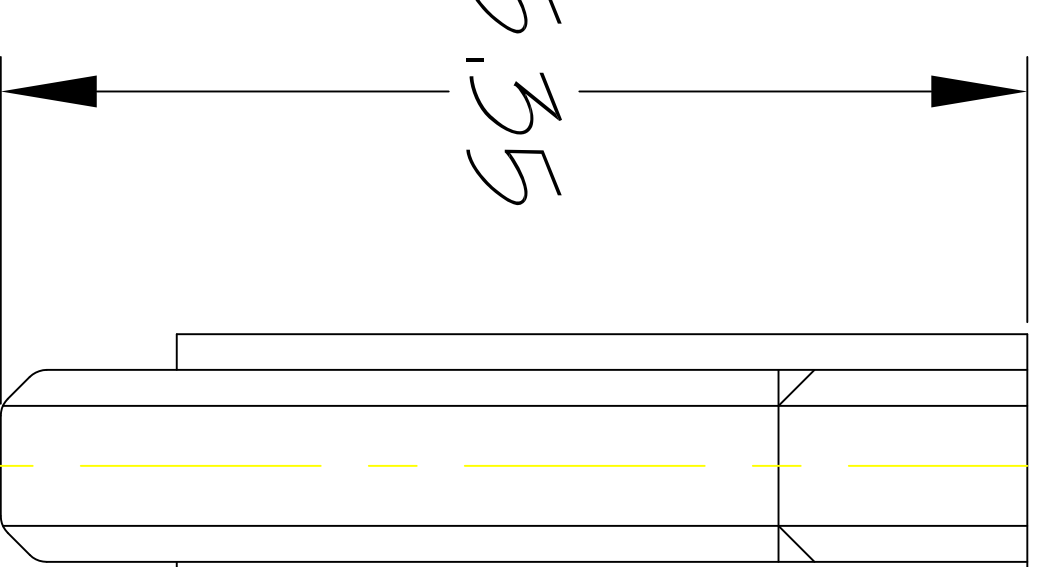

Lower Receiver & Pistol Grip

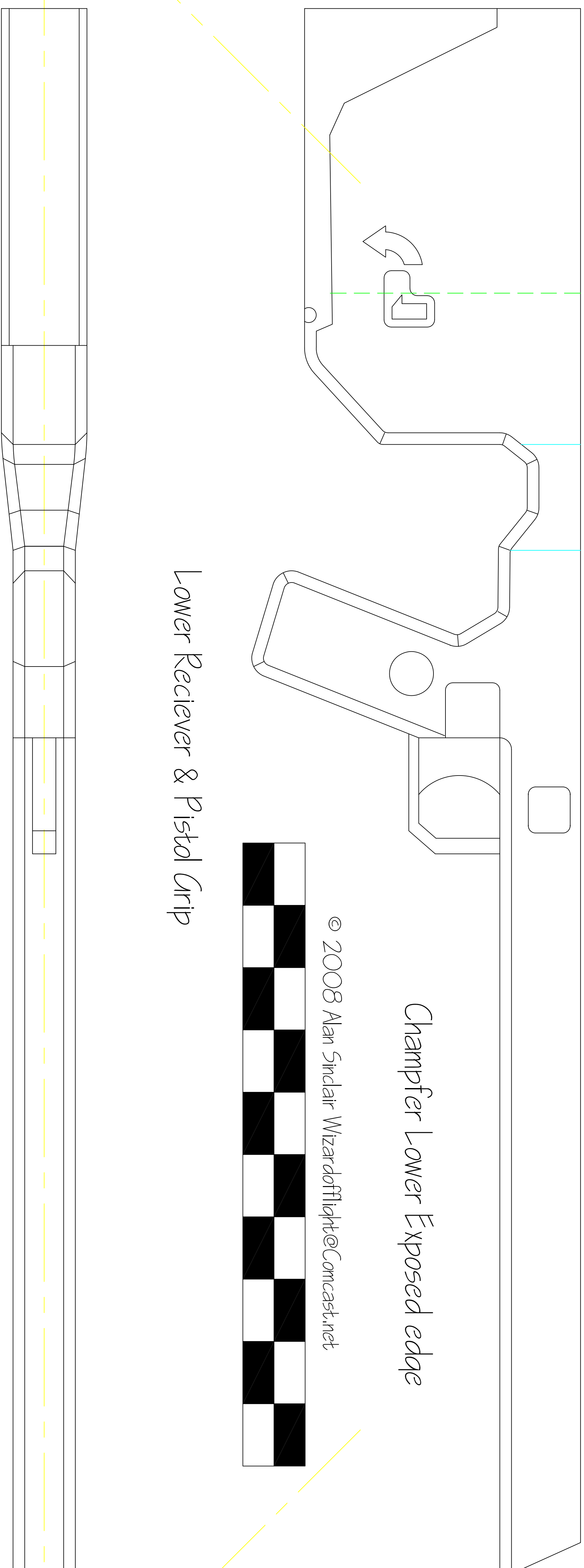

25.20

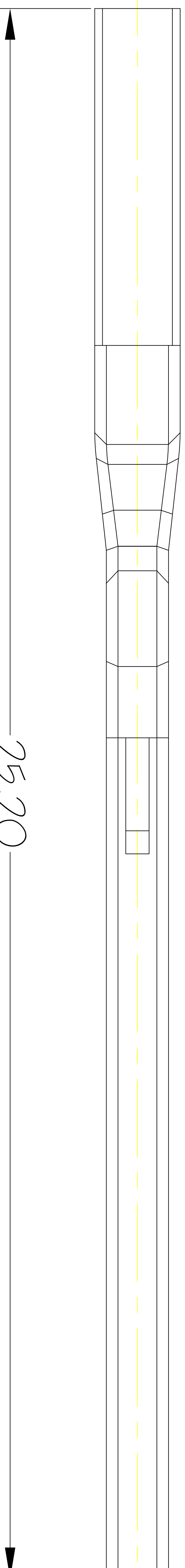

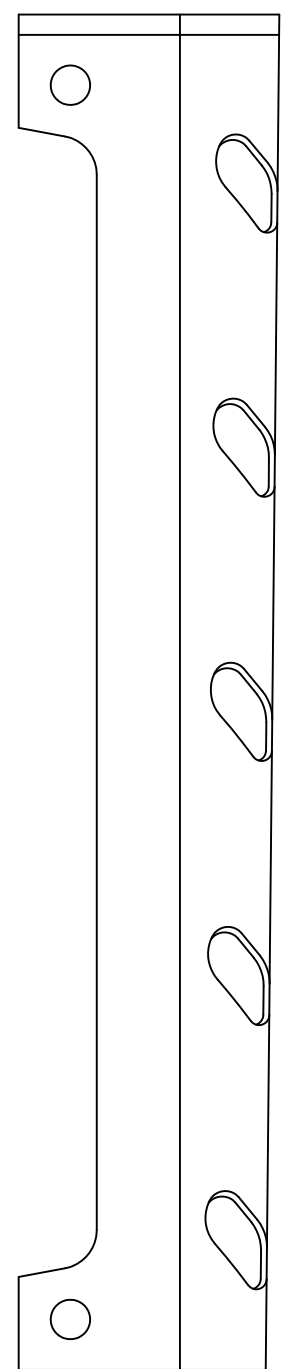
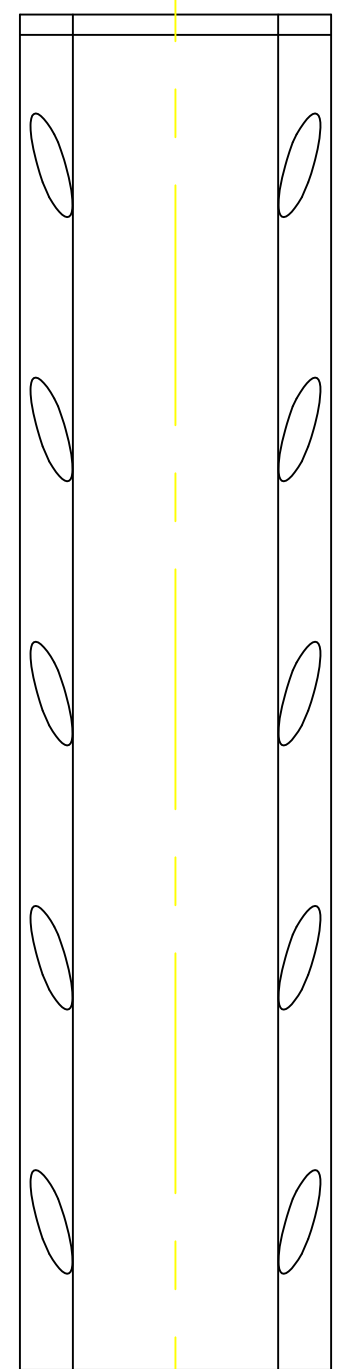

Fwd Heat Shield

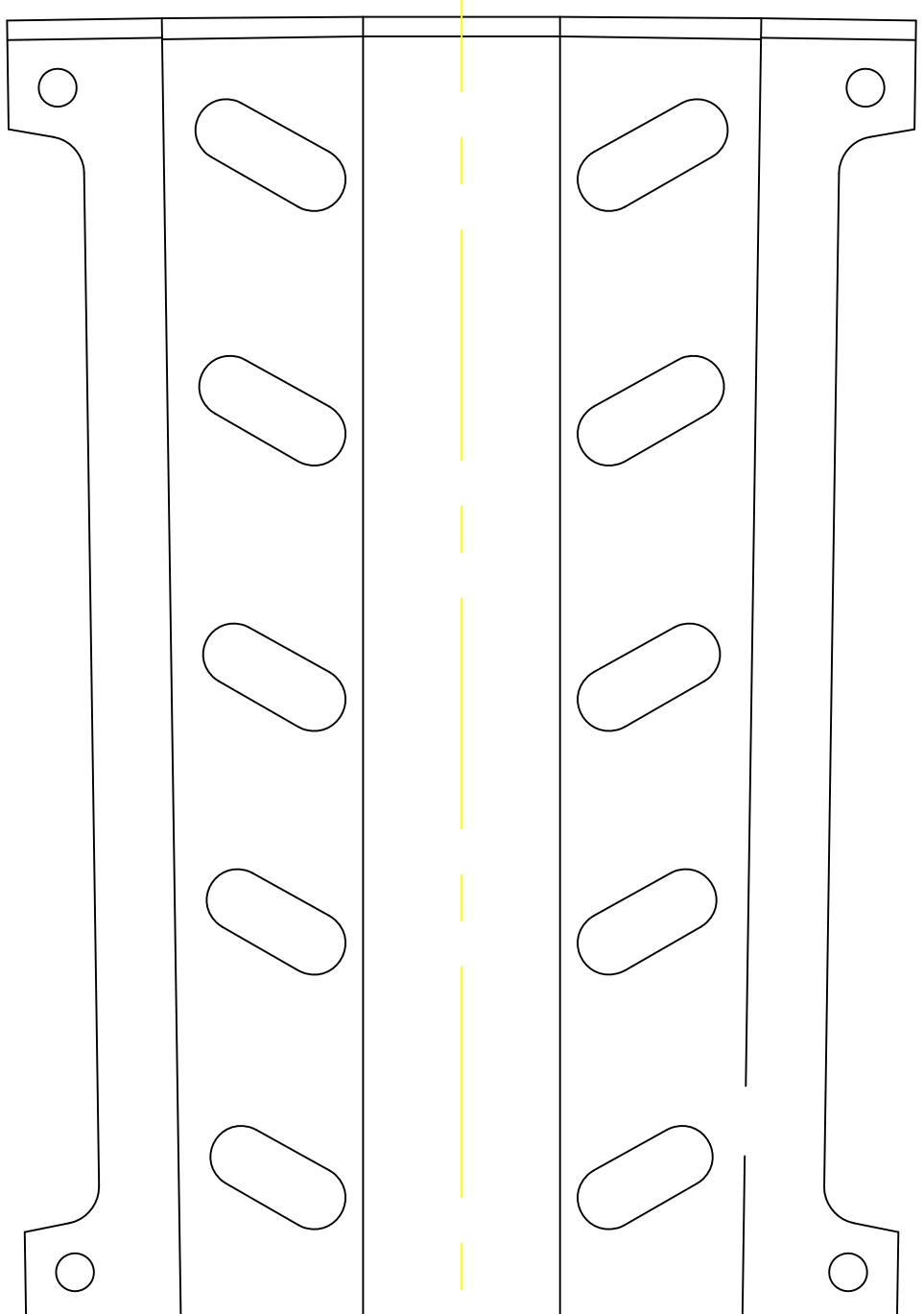

Fwd Heat Shield  
Flat Pattern

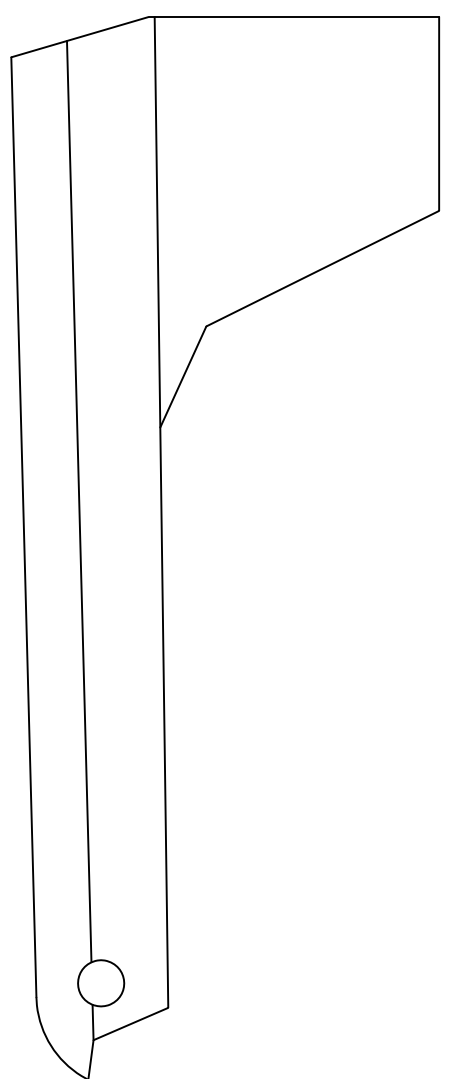

Magazine Cover

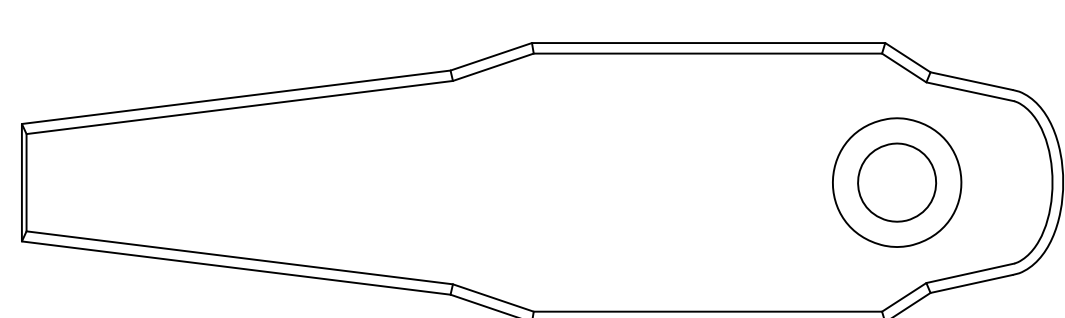
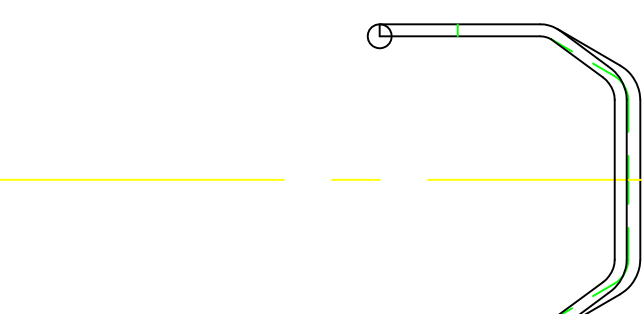
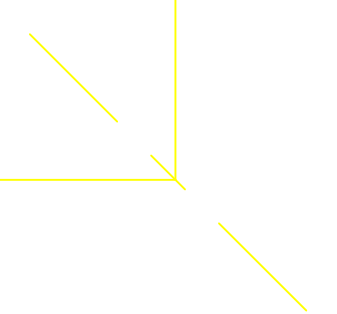
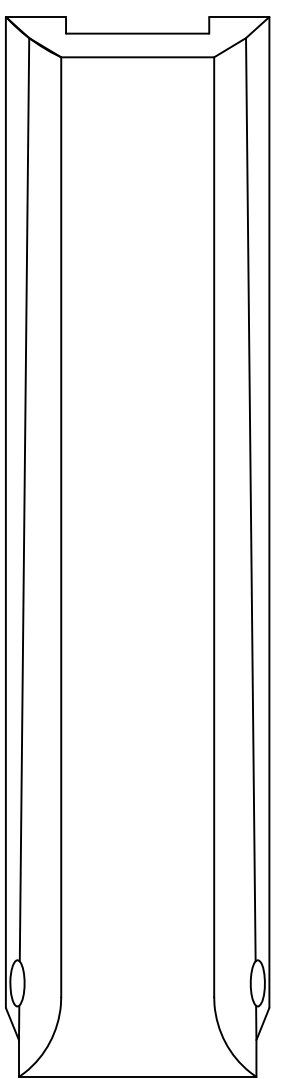

Butt Plate

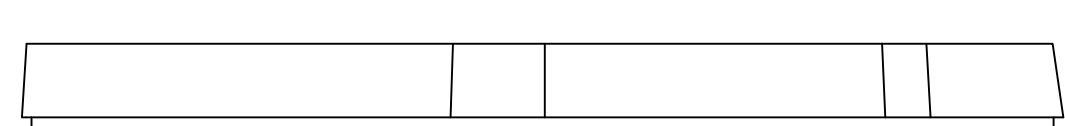

Recoil Pad

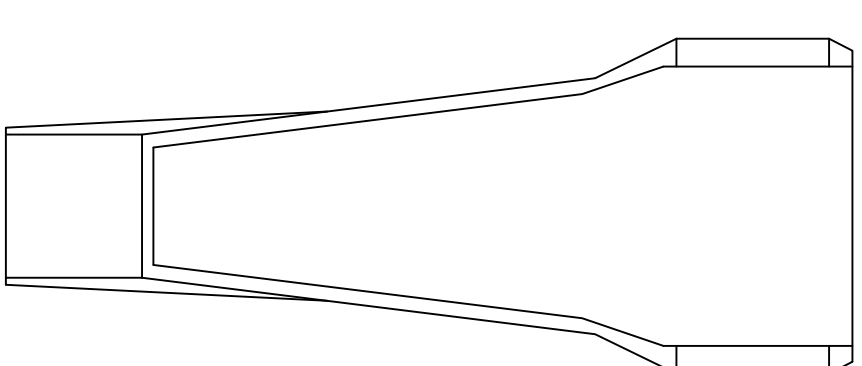
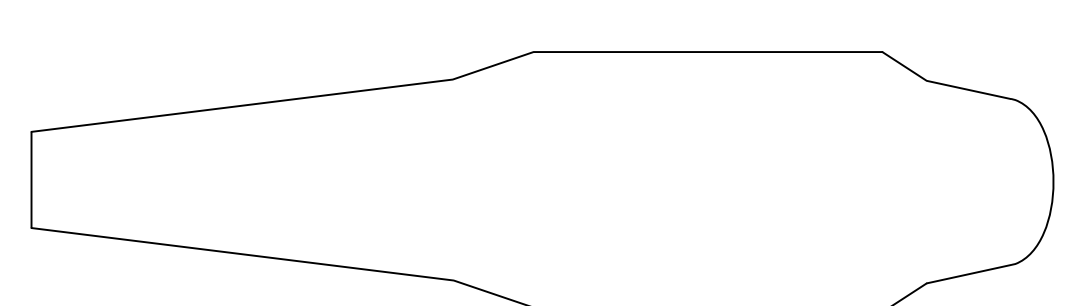

Lower Aft Receiver

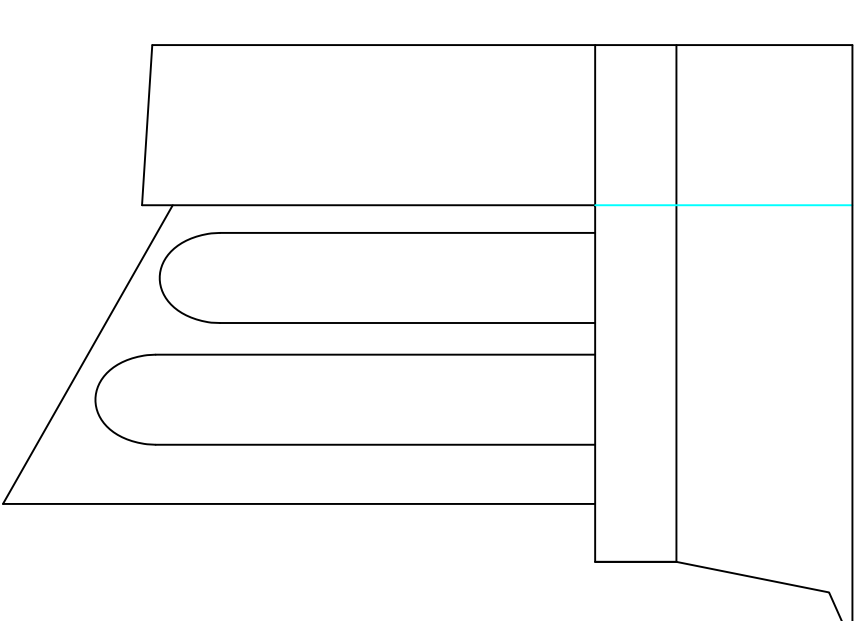

© 2008 Alan Sindair Wizardoflight@Comcast.net

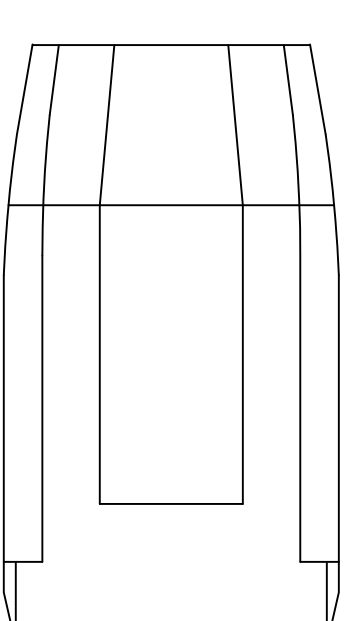
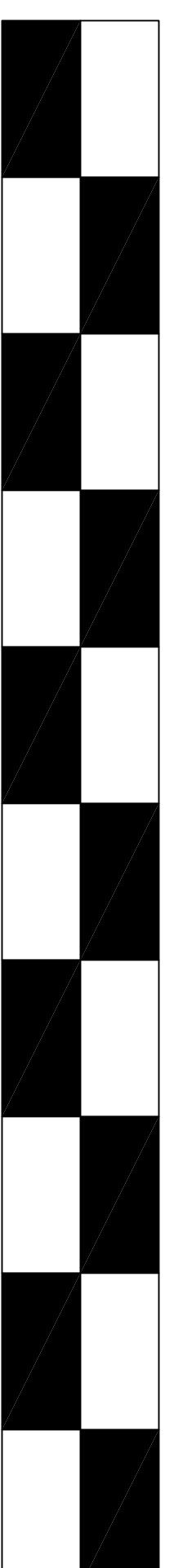

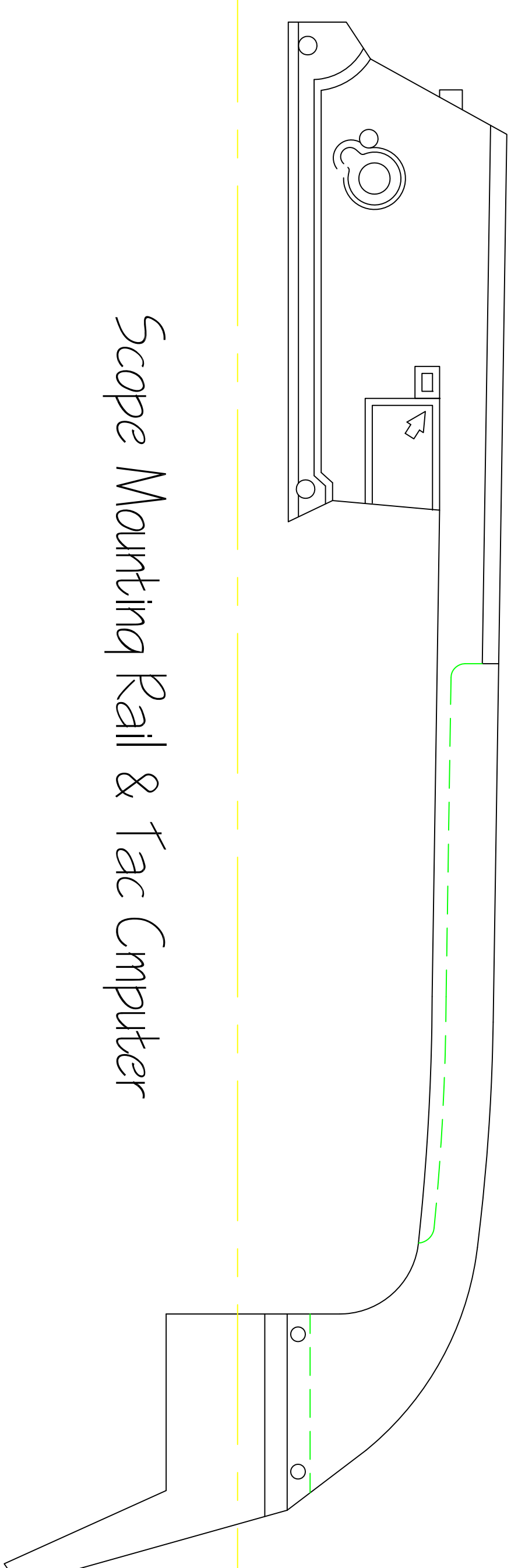
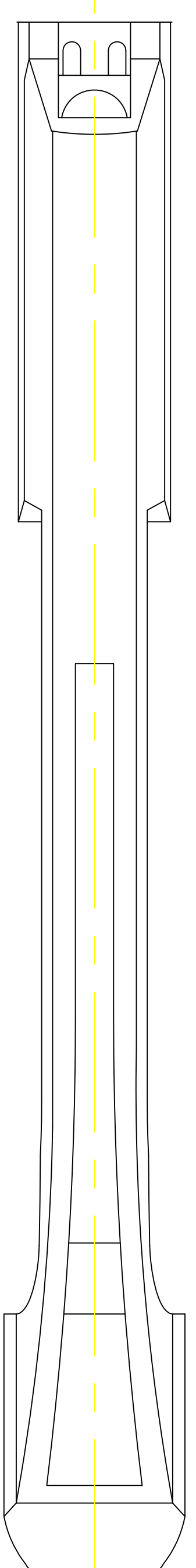
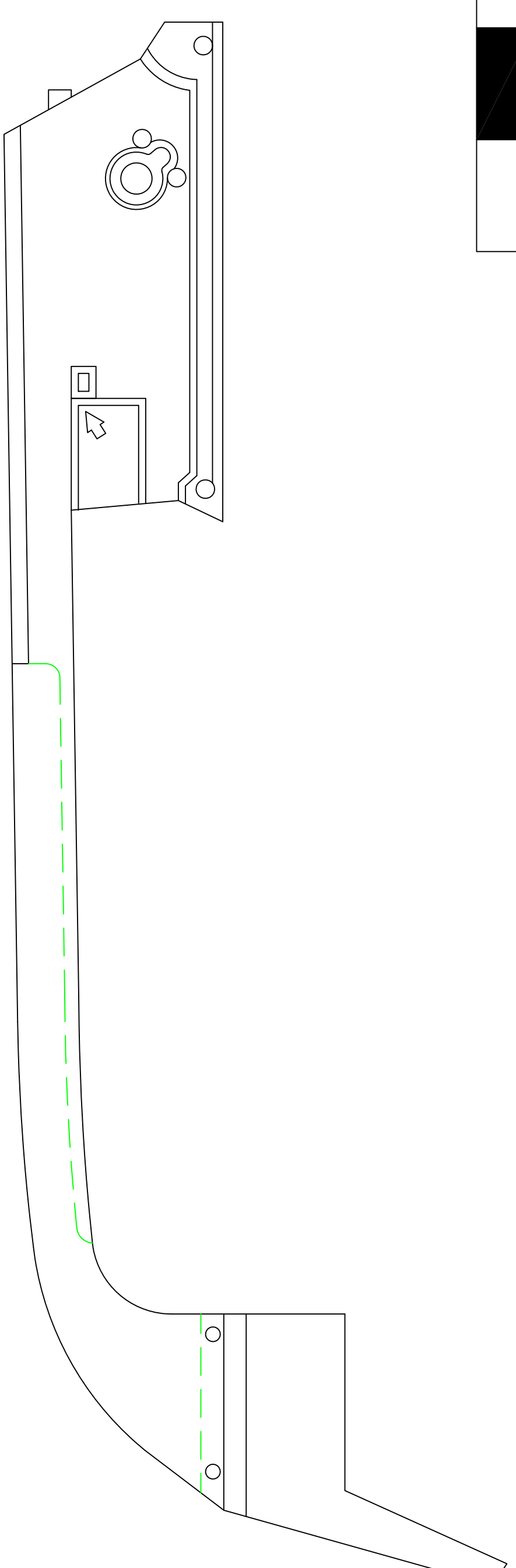
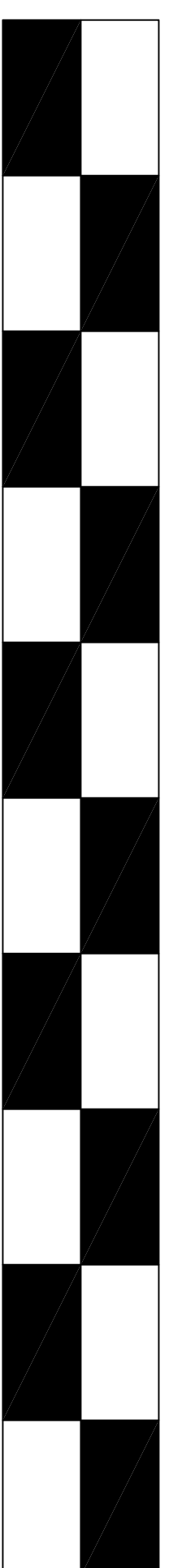

*Scope Mounting Rail & Tac Computer*

